

User/Installation Manual



Remote Control Panel WhisperTouch

WP 5.0 inch | WP 7.0 inch | WP 10.0 inch

whisperpower.com

Table of Contents

1.	Introduction	4
2.	Capabilities	5
3.	Installation	6
3.1.	General Remarks	6
3.2.	List of materials	6
3.3.	Mounting the WhisperPower Touch Display	8
3.4.	Connecting the WhisperPower Touch Display	9
3.5.	Connecting equipment	10
3.5.1	WhisperConnect	10
3.5.2	WPC-bus	11
3.5.3	DDC-bus	11
3.6.	Galvanic isolators	11
3.7.	Connection example	12
4.	Operation	14
4.1	Changing user level	14
4.2	Changing configuration	17
4.3	Troubleshooting	19
5.	Technical Specifications	20
6.	Warranty Terms and Conditions	21

1. Introduction

Congratulations on your purchase of the WhisperPower Touch screen panel, an attractive easy to use touch screen panel to monitor and control those parts of the electrical system of a vessel, yacht, vehicle or land based object which are fitted with a WhisperConnect, WPC-bus or DDC-bus connection. The WP-Touch screen panels come in three sizes: 5 inch, 7 inch and 10 inch. The 5 inch variant can be used to monitor and control a single WhisperPower generator. Complete energy systems can be monitored and controlled on the 7 and 10 inch variants. These also give the possibility to be used with WhisperCare package, giving full remote access to the WP-Touch panel from any smart phone, tablet or computer. When using WhisperCare, you get access to the online WhisperCare cloud portal, opening the possibilities for even more features, like fleet management and full historical data monitoring.

IDENTIFICATION LABEL:

The identification label is located at the back of the Whisper Touch screen panel. Important technical information required for service, maintenance & secondary delivery of parts can be derived from the identification label.



CAUTION!

Never remove the identification label.

LIABILITY:

WhisperPower cannot accept any responsibility for consequential damages due to the use of Whisper Touch display panels, possible errors in the manuals and their results. Copyright© 2020 WhisperPower. All rights reserved. Reproduction, transfer, distribution or storage of part or all of the contents in this document in any form without the prior written permission of WhisperPower is prohibited.

WARNING REGARDING LIFE SUPPORT APPLICATIONS

This equipment is not sold for applications in any medical equipment intended for use as a component of any life support system unless a specific written agreement pertaining to such intended use is executed between the manufacturer and WhisperPower. Such agreement will require the equipment manufacturer either to contract additional reliability testing of the Whisper Touch screen panels and/or to commit to undertake such testing as a part of the manufacturing process. In addition the manufacturer must agree to indemnify and not hold WhisperPower responsible for any claims arising from the use of the Whisper Touch screen panels in the life support equipment.

2. Capabilities

The table below lists which devices are supported by the WhisperPower Touch screen panels.

Art. No.	WP-TOUCH 5" PICCOLO/SCALINO 4/5 GENVERTER	WP-TOUCH 5" SYSTEM PANEL	WP-TOUCH 7" SYSTEM PANEL	WP-TOUCH 10" SYSTEM PANEL
	40280105	40280100	40280101	40280102
GENVERTER RANGE - GRP SOUND SHIELD				
Piccolo 4/5	X	X	X	X
Piccolo 8/10/12/15		X	X	X
Elite 8/12/15		X	X	X
Piccolo GV 1/2/3			X	X
Elite GV 2/3/3 plus			X	X
GENVERTER RANGE - STEEL SOUND SHIELD				
M-GV 8/10/15		X	X	X
W-GV 4 Scalino	X	X	X	X
W-GV 8/8 Scalino/12/15		X	X	X
M-GV 2/3/3 plus			X	X
W-GV 1 scalino /2/3/3 plus			X	X
SQ GENERATOR RANGE				
M-SQ 16/20/25/27/32		X	X	X
M-SQ Pro 15/18/27		X (1)	X (1)	X (1)
W-SQ 12/16/20/25/27/32		X	X	X
W-SQ Pro 15/18/27		X (1)	X (1)	X (1)
ENERGY SYSTEM				
DC Powercube 24/150 48/80			X	X
WP-BC Supreme Pro 40A/60A/80A/100A			X (2)	X (2)
AC Powercube 24/7000 24/14000			X	X
WPC 12V/2000VA / 12V/3000VA / 24V/3500VA / 24V/5000VA / 48V/4000VA / 48V/6000VA			X	X
WPC-BSI 500			X	X
WP-Suntrack 12-48V/65A / 12-48V/80A			X (2)	X (2)
WP-Ion Power Plus 12V - 160Ah / 210Ah			X (3)	X (3)
WP-BMSS Battery Monitor			X	X

- (1) Only the SQ Pro generator fitted with DDC is supported by the touch panels.
- (2) Only available when using the WP-Touch Pro user interface.
- (3) Only supported when used together with a WP Power Plus Whisper Interface box WIB.

3. Installation

3.1. General Remarks

Local and/or special regulations may apply depending on the type of installation involved. It is essential that each and every circuit in the electrical system is properly installed by a qualified electrician using all applicable standards. Refer to the wiring diagram for details of electrical connections.



CAUTION!

Risk of electric shock, personal injury, explosion and/or equipment damage

- Do not work on the WhisperPower Touch screen panel or the electrical installation while it is still connected to a power source.
- All electrical safety/shutdown and circuit breaking systems have to be installed separate from the WhisperPower Touch screen panel.

3.2. List of materials

When unpacking the box containing the WhisperPower Touch screen panel, you should find the items listed below, depending on the type of touch screen panel ordered. If any of these items are missing or damaged, please contact WhisperPower:

WP-TOUCH screen panel full color 5" - Piccolo/Scalino 4/5 Genverter

- WP-Touch screen panel
- 4 Mounting screws with clips
- WhisperConnect cable 15 meter
- 2 WhisperConnect terminators
- User/installation manual

WP-TOUCH screen panel full color 5

- WP-Touch screen panel
- 4 Mounting screws with clips
- WhisperConnect cable 15 meter
- WhisperConnect cable 0,5 meter
- 1 WhisperConnect splitter
- 2 WhisperConnect terminators
- User/installation manual

WP-TOUCH screen panel full color 7" - System panel

- WP-Touch screen panel
- 4 Mounting screws with clips
- WhisperConnect cable 15 meter
- WhisperConnect cable 0,5 meter
- 1 WhisperConnect splitter
- 2 WhisperConnect terminators
- User/installation manual

WP-TOUCH screen panel full color 10" - System panel

- WP-Touch screen panel
- 4 Mounting screws with clips
- WhisperConnect cable 15 meter
- 2 WhisperConnect cables 0,5 meter
- 2 WhisperConnect splitter
- 3 WhisperConnect terminators
- 1 Inline data bus coupler
- Galvanic isolator for WhisperConnect
- Galvanic isolator for DDC bus
- User/installation manual

3.3 Mounting the WhisperPower Touch Display

Create a mounting hole according to the dimension specifications found below. Install the WhisperPower Touch screen panel. Fix the panel with the four clips with screws. Please note the touch screen panel is meant for in-door/interior use. It must be installed in a dry and clean place protected from strong vibrations. The touch screen panel must be mounted so as to avoid any contact with acid from the battery, dust, rain, snow or liquids of any type. Long exposure to direct sunlight may cause discoloration of the touch screen panels.

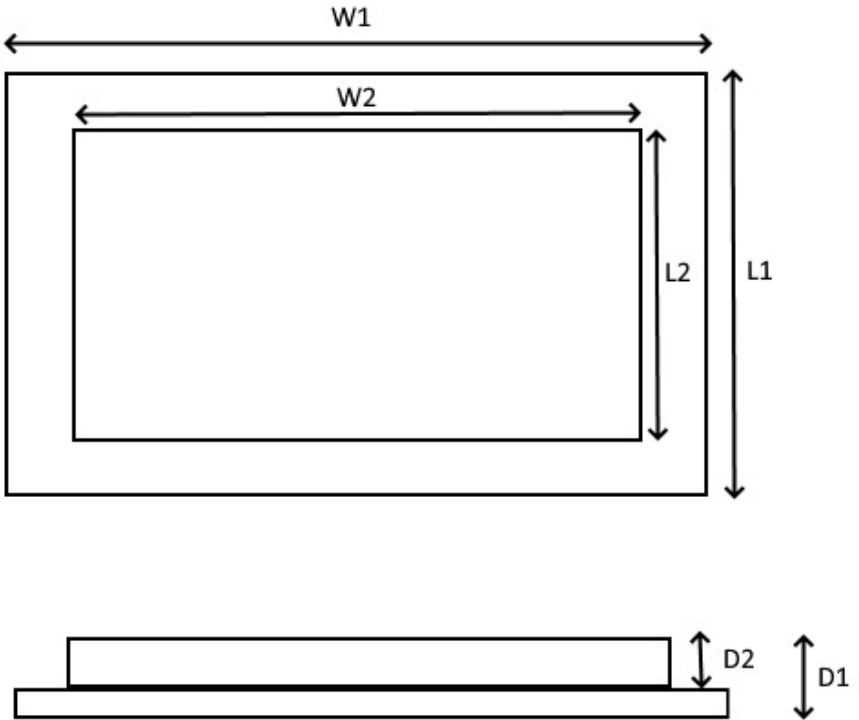

	WP-TOUCH 5" PICCOLO/SCALINO 4/5 GENVERTER	WP-TOUCH 5" SYSTEM PANEL	WP-TOUCH 7" SYSTEM PANEL	WP-TOUCH 10" SYSTEM PANEL
Art. No.	40280105	40280100	40280101	40280102
External width (W1)	150 mm	150 mm	206 mm	280 mm
External length (L1)	110 mm	110 mm	139 mm	186 mm
External depth (D1)	40 mm	40 mm	40 mm	42 mm
Internal width (W2)	139 mm	139 mm	194 mm	248 mm
Internal length (L2)	91 mm	91 mm	117 mm	159 mm
Internal depth (D2)	32 mm	32 mm	32 mm	34 mm

3.4 Connecting the WhisperPower Touch Display



WARNING!

Wrong or improper connections may cause damage to your WhisperPower Touch screen panel or any other equipment connected to the system. Wrong installation is not covered by guarantee.

- Remove the green 3 pole power connector from the rear side of the panel.
- Connect the DC (plus and minus) and the earth connection as shown on the rear side of the panel.
- Connect the communication busses (WhisperConnect, WPC-bus, DDC bus) of all the devices in the energy system as explained below. For more information on installation of these communication busses see the section below and the manual of the specific communication bus.
- If applicable connect the touch panel to the WhisperCare equipment. See the manual of WhisperCare for more details.
- Reconnect the green 3 pole power connector.

The power supply to the touch screen panel must be fused by a fast blow 3A fuse. All equipment connected to the touch screen panel must be powered by a common ground supply. For example this means the negative sides of the starter battery and service battery must be connected together in a system. When it is not possible to create a common ground system, one must use galvanic isolators on all communication busses. Galvanic isolators are standard included with the 10 inch touch screen panel.

3.5. Connecting equipment



WARNING!

Wrong or improper connections may cause damage to your WhisperPower Touch screen panel or any other equipment connected to the system.

Wrong installation is not covered by guarantee.

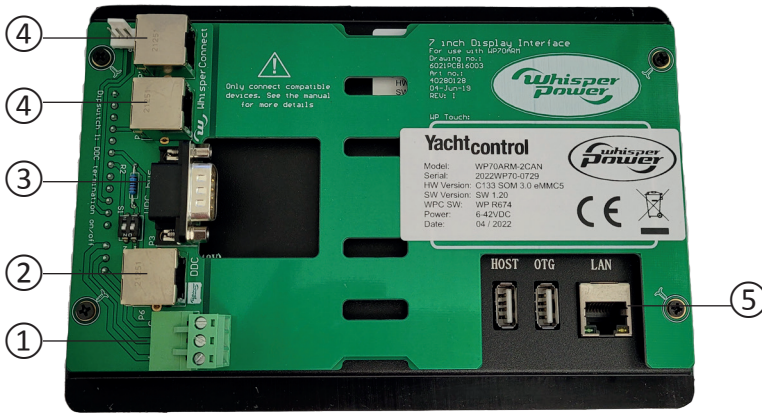

- 1 – Power supply connection
- 2 – DDC bus
- 3 – RS232
- 4 – WhisperConnect
- 5 – LAN

3.5.1 WhisperConnect

Devices with WhisperConnect capabilities can be connected in a WhisperConnect bus by daisy chaining them together. At both ends of the bus a terminator must be placed. See the WhisperConnect manual for more details.

3.5.2 WPC-bus

Devices with WPC-bus can be connected to the touch panel by using a WPC-RS232 interface or WPC-CAN interface. The WPC-RS232 interface connects to the RS232 connection on the touch panel. The WPC-CAN integrates into the WhisperConnect bus. See the manual of the interfaces for more details.

3.5.3 DDC-bus

Devices with DDC-bus capabilities can be connected in a DDC-bus by daisy chaining them together. See the manual of the devices for more details.

3.6. Galvanic isolators

When using the 10 inch touch screen panel or when using the touch screen panel in a system where common ground between equipment is not possible, galvanic isolators must be used for the communication busses. The galvanic isolators must be installed directly to the touch screen panel. No equipment must be connected to the communication busses between the galvanic isolators and the touch screen panels. Equipment can be connected as normal to the secondary side of the galvanic isolator.

3.7 Connection example

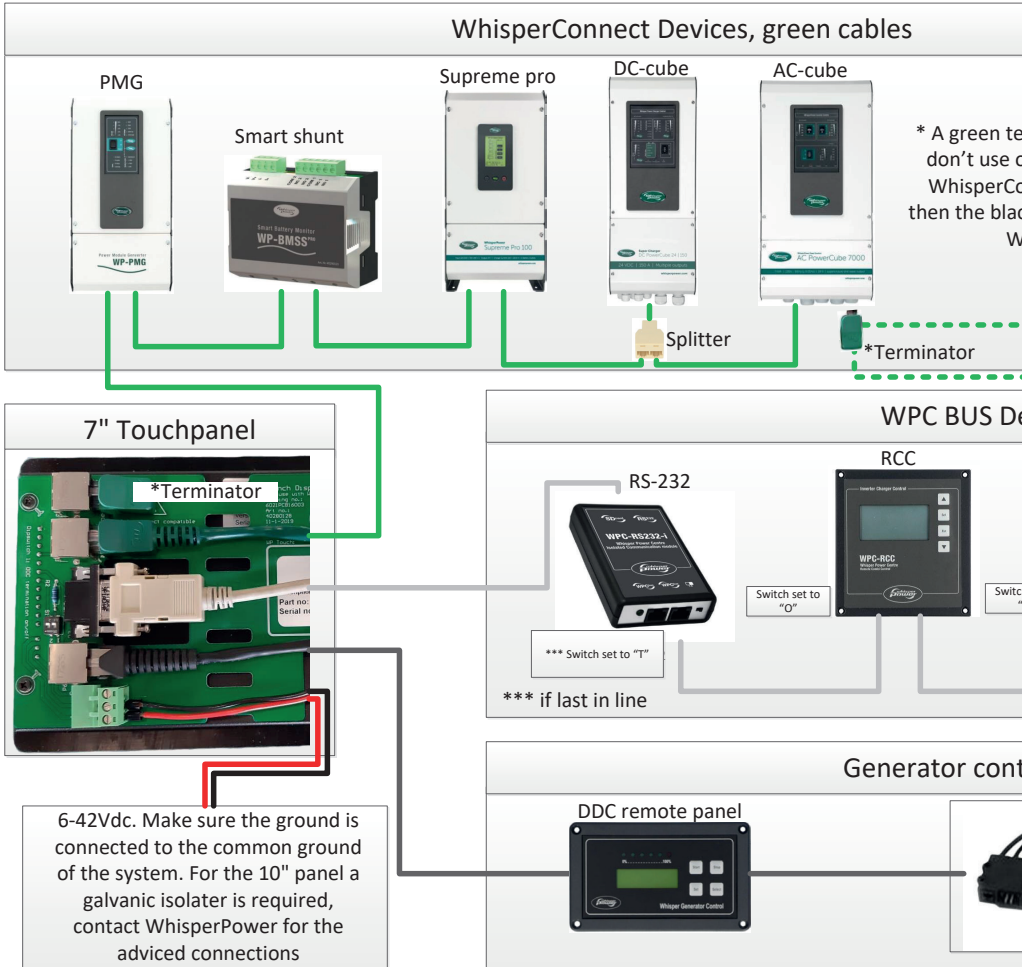

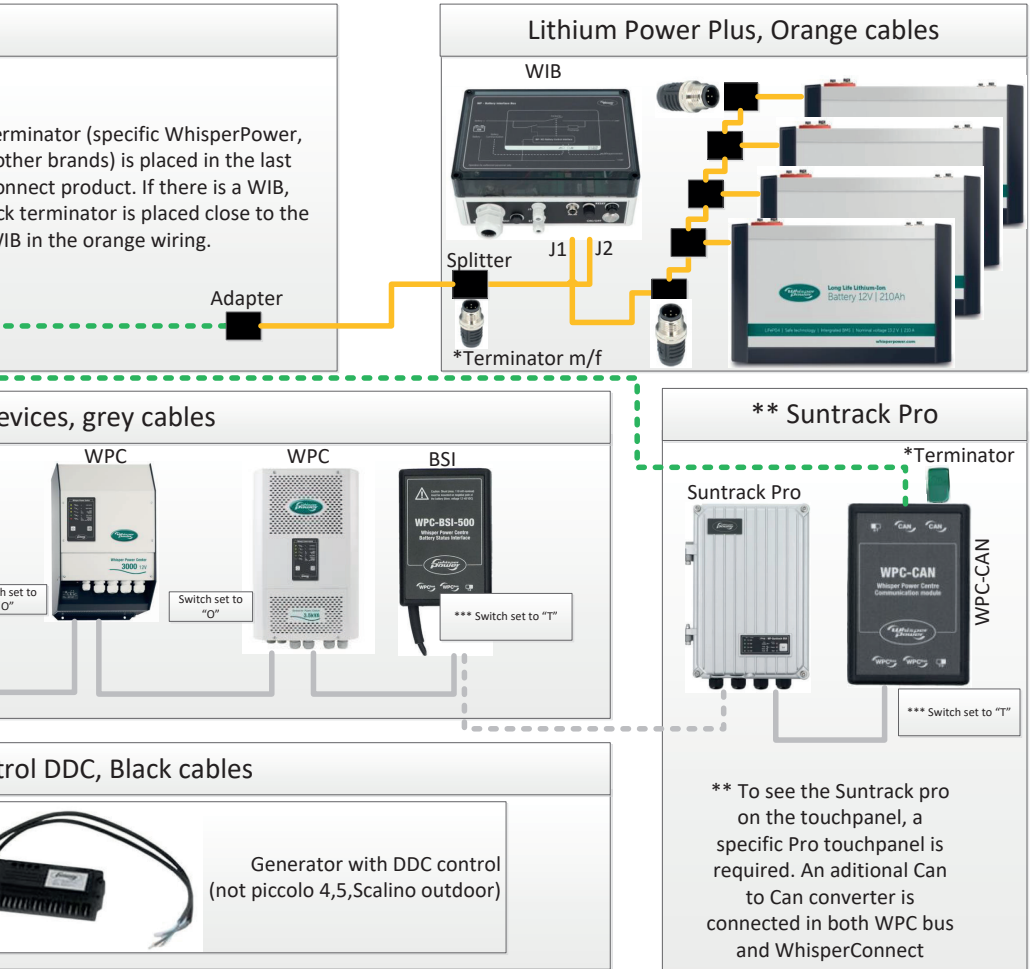

4. Operation

The WhisperPower Touch screen panels can be supplied with a classic user interface, pro user interface or piccolo user interface.

WP-Touch classic user interface

Dark themed touch panel with configurable device layout. Up to two chargers, up to two inverters, up to two battery banks and up to one generator can be used with the touch panel.

WP-Touch pro user interface

Light themed touch panel with pre-configured device layout. Plug and play capability due to pre-configuration done in our factory. Complete system monitor and control including Solar.

Piccolo user interface

Light themed touch panel with layout for controlling a single piccolo or scalino 4/5. Plug and play capability due to pre-configuration done in our factory.

4.1 Changing user level





WARNING!

Improper settings can make the installation inoperable and/or damage the installation. Wrong configuration is not covered by guarantee.

To gain access to advanced features on the touch panel screen, like settings, a higher user level is required. A user level can be gained by entering the correct password in the maintenance page. To revert back to user level 'user' one can leave the password blank or enter a wrong password and press verify.

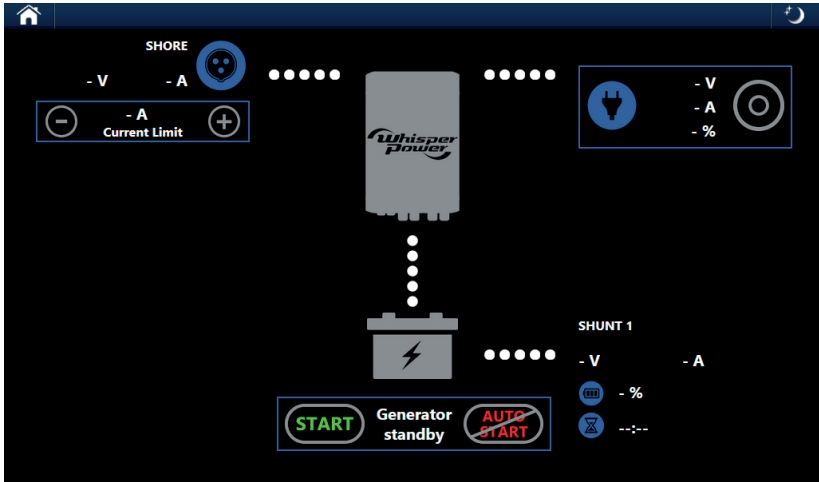
USER LEVEL	PASSWORD
User	
Basic	0000
Expert	1234
Installer level 1	8051



Press the home button 

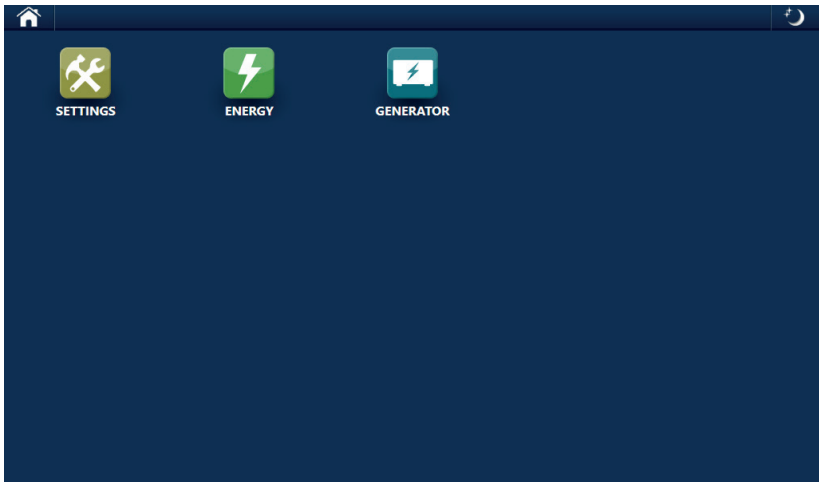

Press the settings button 

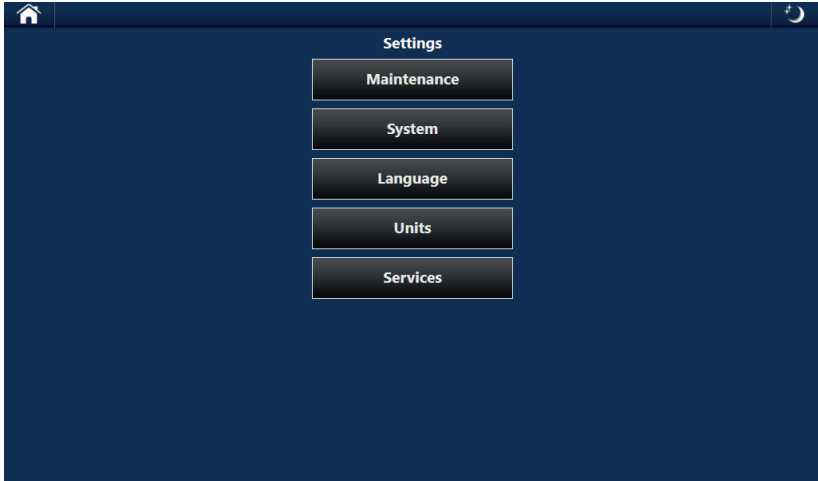

Press the maintenance button

Maintenance

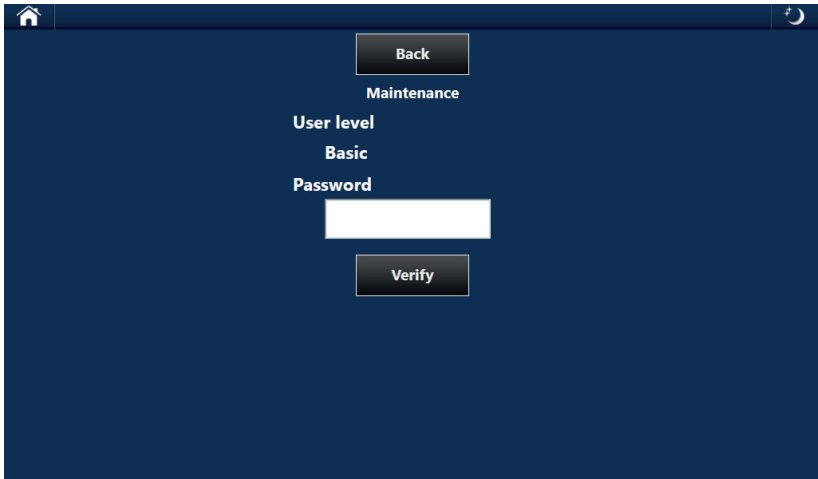

Fill in the password



Password

Press the verify button

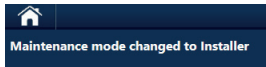
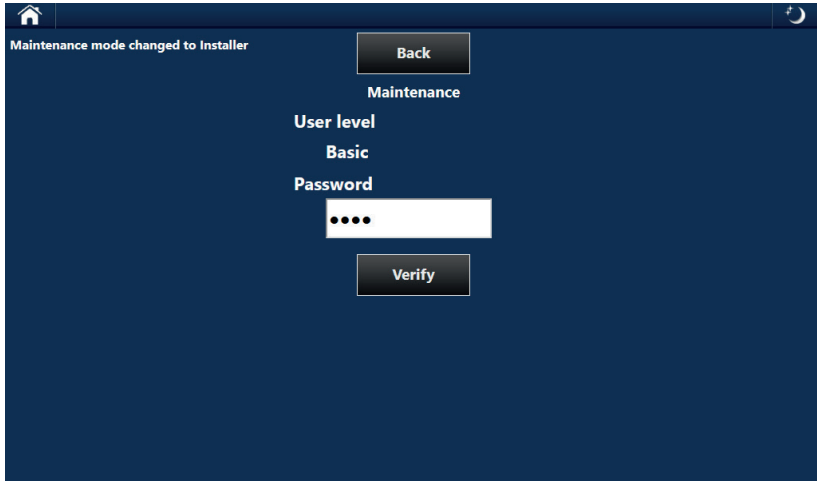
Verify



A message will show when successfully changed user level

Press the home button  or the back button  to return to the main

4.2 Changing configuration



WARNING!

Improper settings can make the installation inoperable and/or damage the installation. Wrong configuration is not covered by guarantee.

The configuration menus become accessible when the user level is set to installer. The main configurations are divided over multiple configuration pages: energy config and generator config. Using these parameters, one can select which devices are connected and monitored on the touch panel. Touch panels with the WP-Touch pro user interface are configured at the factory and cannot be changed by the user.

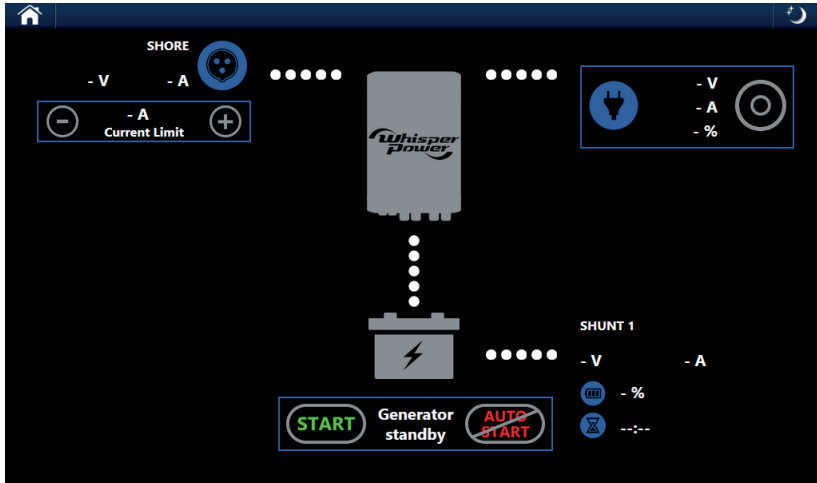

Press the home button 

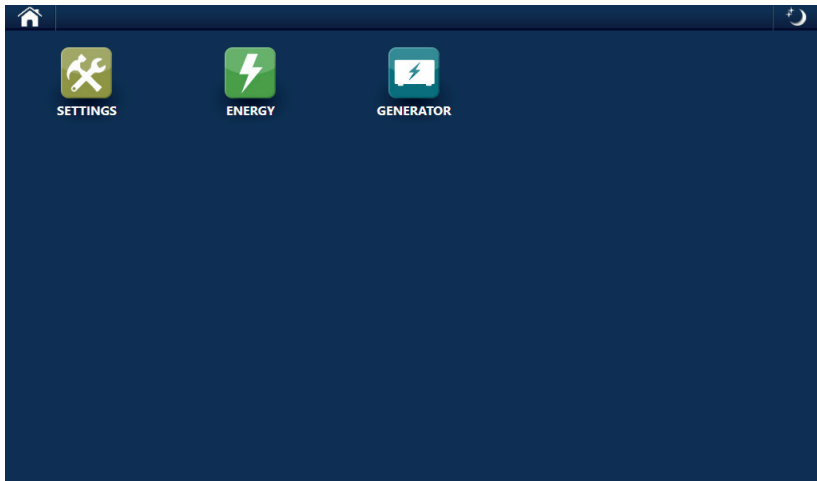

Press the settings button 

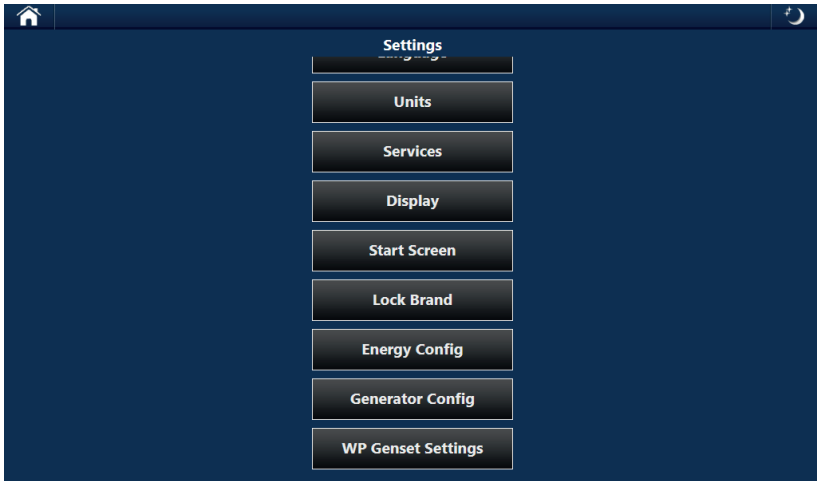

Press the energy config button to access the energy



Press the generator config button to access the generator config parameters

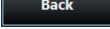

Press the home button  or the back button  to return to the main

4.3 Troubleshooting

No visible screen

No power – Check power supply and fusing

Screen is in standby – Touch the screen to wake it up

Device data is not shown

Faulty communication installation – Check the communication wiring between the touch screen panel and the equipment

Wrong configuration – Consult dealer or contact WhisperPower

5. Technical Specifications

SPECIFICATIONS

WP-TOUCH screen panel full color 5" - Piccolo/Scalino 4/5 Genverter

Input voltage	6-42 VDC
Power consumption	100mA to 240 mA
Dimensions WhisperTouch 5" (lxw)	110 mm x 150 mm
Installation depth WhisperTouch 5"	40 mm
Weight WhisperTouch 5"	250 gr
Operating temperature	-25°C..55°C
Installation advice	For interior use

WP-TOUCH screen panel full color 5

Input voltage	6-42 VDC
Power consumption	100mA to 240 mA
Dimensions WhisperTouch 5" (lxw)	110 mm x 150 mm
Installation depth WhisperTouch 5"	40 mm
Weight WhisperTouch 5"	250 gr
Operating temperature	-25°C..55°C
Installation advice	For interior use

WP-TOUCH screen panel full color 7" - System panel

Input voltage	6-42 VDC
Power consumption	150mA to 750 mA
Dimensions WhisperTouch 7" (lxw)	139 mm x 206 mm
Installation depth WhisperTouch 7"	40 mm
Weight WhisperTouch 7"	300 gr
Operating temperature	-25°C..55°C
Installation advice	For interior use

WP-TOUCH screen panel full color 10" - System panel

Input voltage	15-36 VDC
Power consumption	100mA to 650 mA
Dimensions WhisperTouch 10" (lxw)	186 mm x 280 mm
Installation depth WhisperTouch 10"	42 mm
Weight WhisperTouch 10"	
Operating temperature	-25°C..55°C
Installation advice	For interior use

6. Warranty Terms and Conditions

WhisperPower guarantees that the equipment has been built according to the legally applicable standards and specifications. WhisperPower assures the product warranty of the Touch screen panels during two years after purchase, on the condition that all instructions and warnings given in this manual are taken into account during installation and operation. The warranty is limited to the costs of repair and/or replacement of the product by WhisperPower only. Costs for installation labour or shipping of the defective parts are not covered by this warranty.



Enjoy Green Energy

WhisperPower BV

Kelvinlaan 82,
9207 JB Drachten
The Netherlands

www.whisperpower.com
sales@whisperpower.com

